

PRING

COMMUNICATION PLATFORM
& PACKAGING CONCEPT

VERSION **1.0**

2016-06-23

Copyright ©2016 Pring

Basic Analysis

- + **VISION** (*goal*) – Lead the sexual health care market for men.
- + **MISSION** (*how*) – By using the latest cutting edge technology, medical knowhow and experience.



- + *Primary* – Men with a desire for a better and **stronger erection**.
- + *Secondary* – Men with temporarily **erection problem** and their partner(s).





Logotype

Logo - Black

Logo - White

ON/OFF button

Alt. 1



DESIGNER'S
CHOICE

Alt. 2



Alt. 3



PRING
PLATFORM

PRING
LOGOTYPE

LOGO IN
ACTION

Logo alt. 1



PRING
PLATFORM

PRING
LOGOTYPE

LOGO IN
ACTION

Logo alt. 2



PRING
PLATFORM

PRING
LOGOTYPE

LOGO IN
ACTION

Logo alt. 3



Alt. 1

invotron A/S

DESIGNER'S
CHOICE



Alt. 2

INVOTRON A/S

Alt. 3

INVOTRON A/S

Typography

Font alt. 1

Pring®

DESIGNER'S
CHOICE

Headline

Soho Gothic Pro - Commercial font

The Pring technology is based on proven research and development that gives men an instant and strong erection boost.

The working mechanism is neural/tissue/blood flow stimulation. It's a simple external device applied on the penis, it runs on low voltage motors that stimulates the blood flow to the penis and gives instant erection.

The erection stops after use and there's no proven negative side effects. No prescription from doctor needed.

The Pring is USB rechargeable, made in a flexible and stretchy body safe silicone. Easy to use and easy to clean.

Disclaimer: This product is used for novelty use only.

Size: 40 x 40 x 35mm Ø20mm
USB cable included

invotron A/S

Font alt. 2

@Pring®

Headline

Open Sans - Google font

The Pring technology is based on proven research and development that gives men an instant and strong erection boost.

The working mechanism is neural/tissue/blood flow stimulation. It's a simple external device applied on the penis, it runs on low voltage motors that stimulates the blood flow to the penis and gives instant erection.

The erection stops after use and there's no proven negative side effects. No prescription from doctor needed.

The Pring is USB rechargeable, made in a flexible and stretchy body safe silicone. Easy to use and easy to clean.

Disclaimer: This product is used for novelty use only.

Size: 40 x 40 x 35mm Ø20mm
USB cable included

invotron A/S

Font alt. 3

pring®

Headline

Calibri - Windows font

The Pring technology is based on proven research and development that gives men an instant and strong erection boost.

The working mechanism is neural/tissue/blood flow stimulation. It's a simple external device applied on the penis, it runs on low voltage motors that stimulates the blood flow to the penis and gives instant erection.

The erection stops after use and there's no proven negative side effects. No prescription from doctor needed.

The Pring is USB rechargeable, made in a flexible and stretchy body safe silicone. Easy to use and easy to clean.

Disclaimer: This product is used for novelty use only.

Size: 40 x 40 x 35mm Ø20mm
USB cable included

invotron A/S

Colors



PANTONE
PROCESS CYAN C



PANTONE
DS 327-2 C

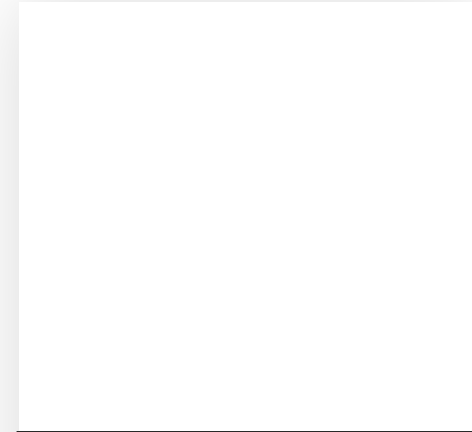

PANTONE
PROCESS WHITE C

PRING
PLATFORM

COLORS

PRODUCT
RENDERING



Packaging Concept

"Overall design principles have been to make a brand recognition through all the elements - logo, package, storage case, on/off button matching the original shape of the Pring product."

PRING PLATFORM

PACKAGING CONCEPT

WHATS IN THE BOX

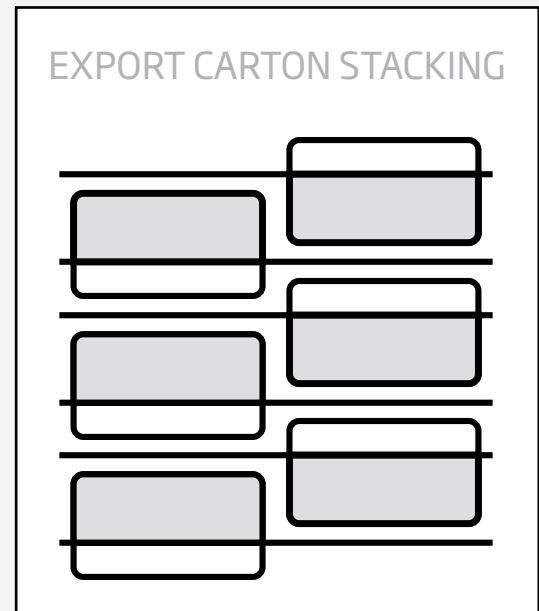
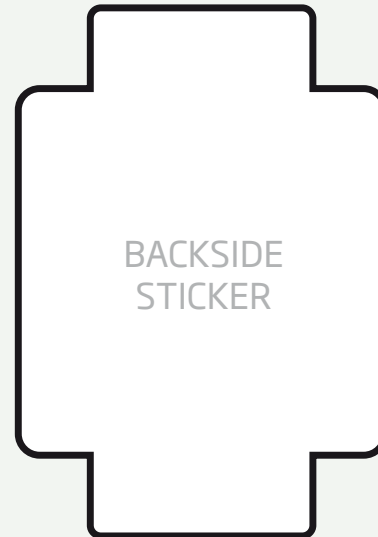
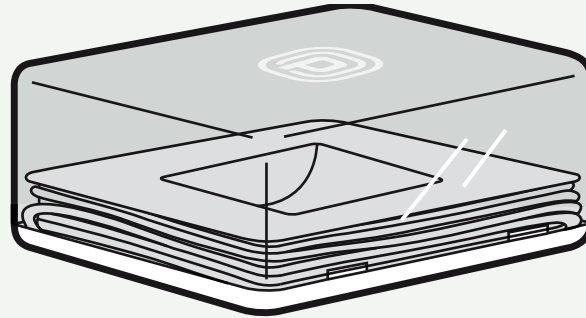
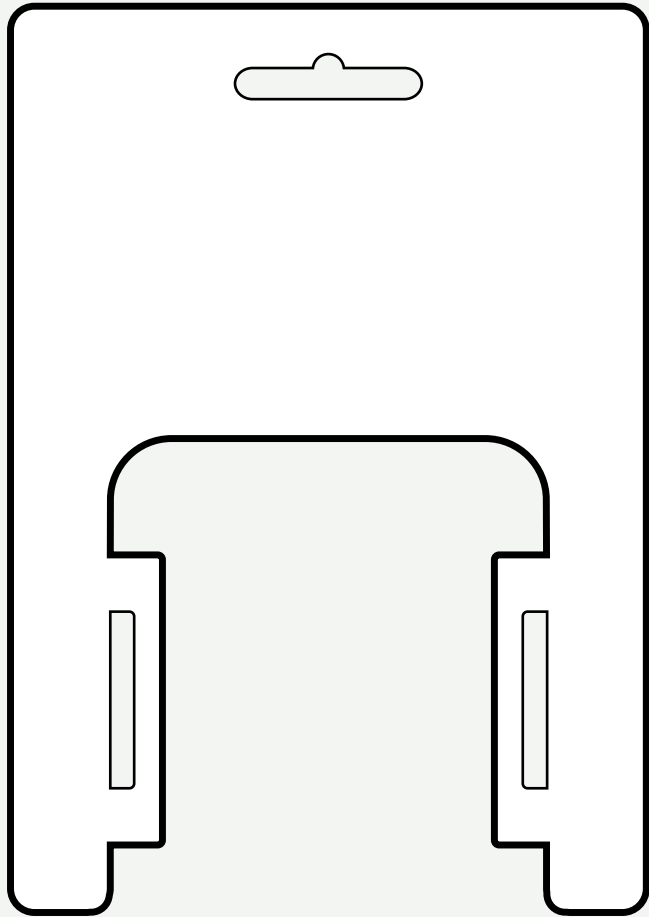

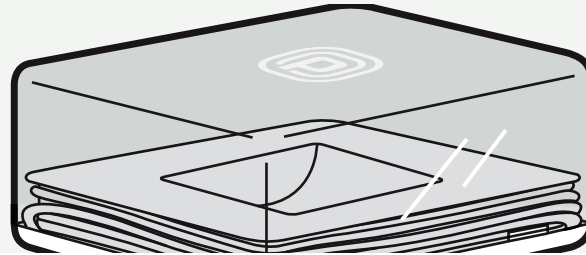
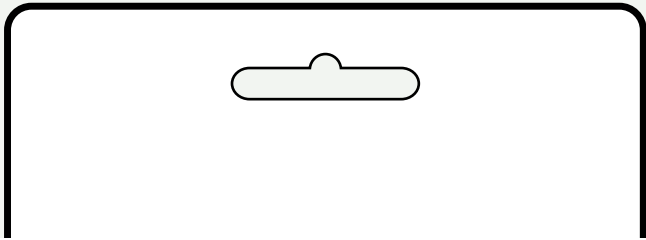

Packaging Advantages

Packaging and storage box, hygienic,
environmental, protection, logistic efficient

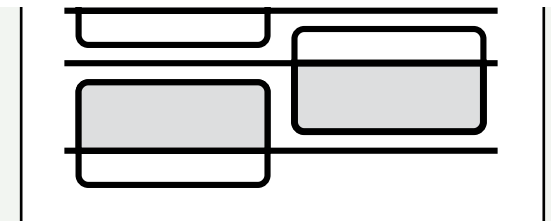
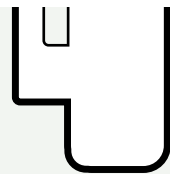

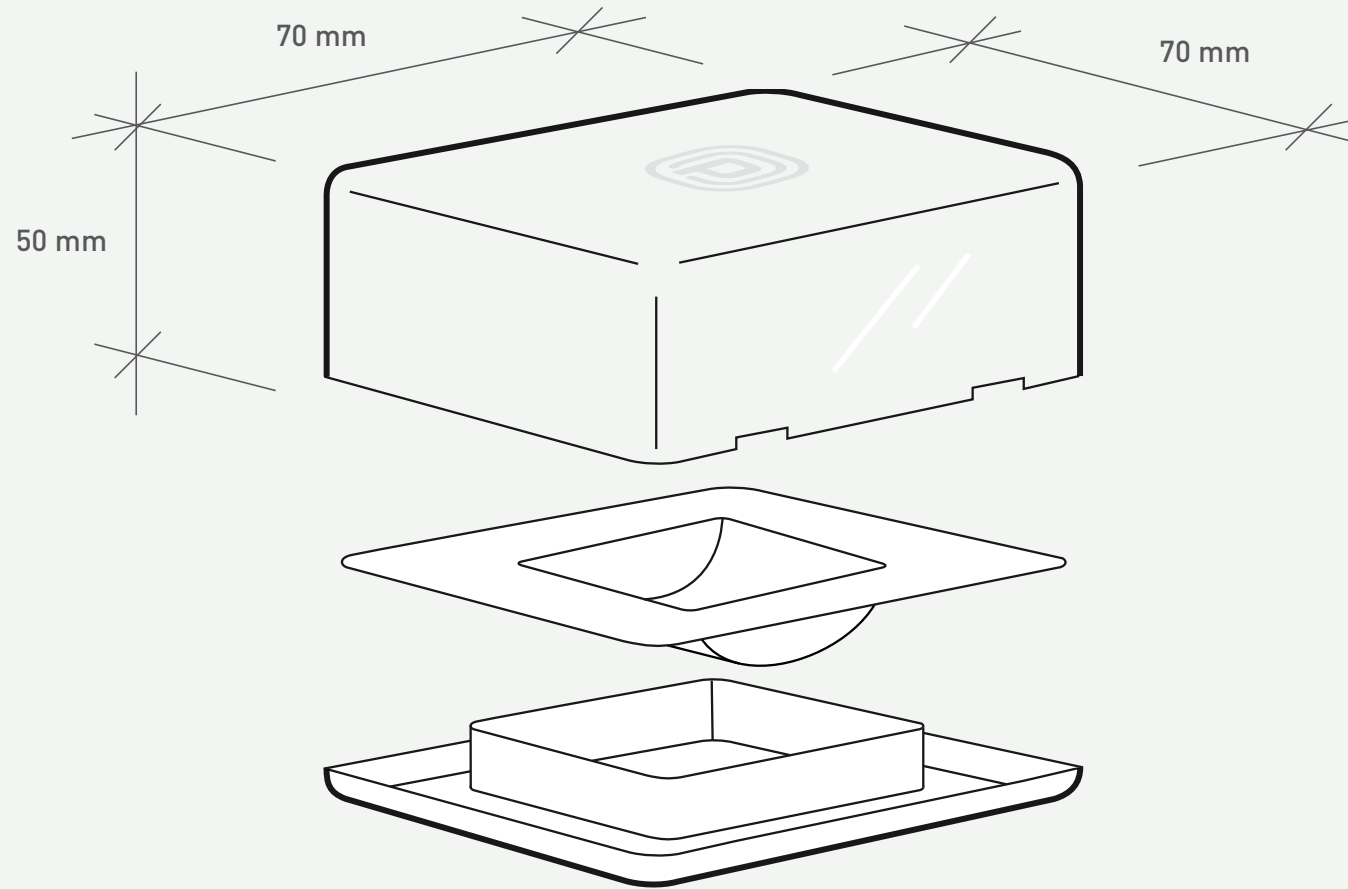

Package alt. 1



Front



Back



Sticker

DESIGNER'S
CHOICE

Package alt. 2



Front



Back

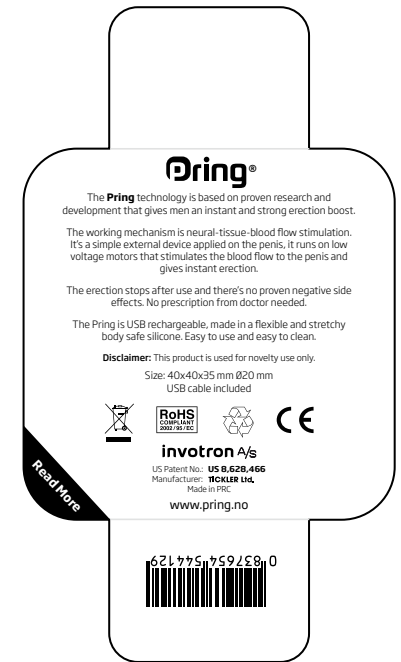

Sticker

Package alt. 3



Front



Back

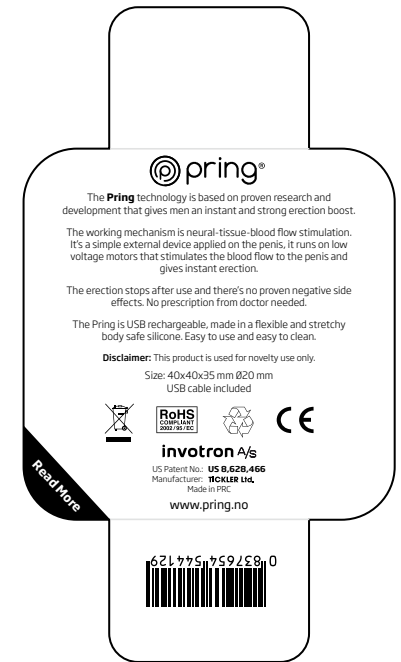

Sticker

**LET'S PRING IT TO
THE MARKET!**

TAKK/TACK/THANK YOU